

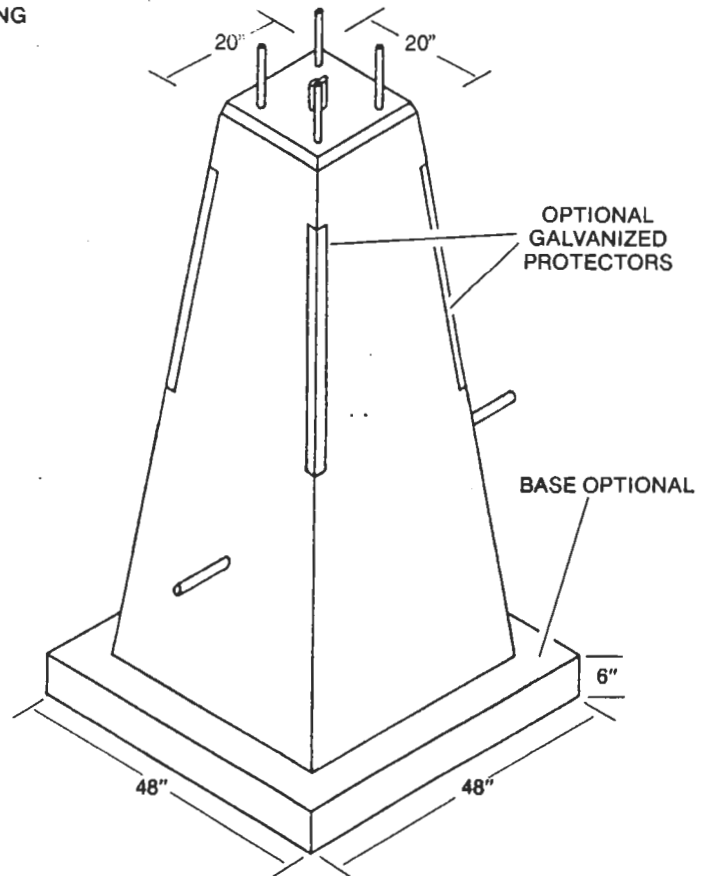

# LIGHT POLE FOOTINGS

ITEM # C19•501

WEIGHT: 6175 LB.

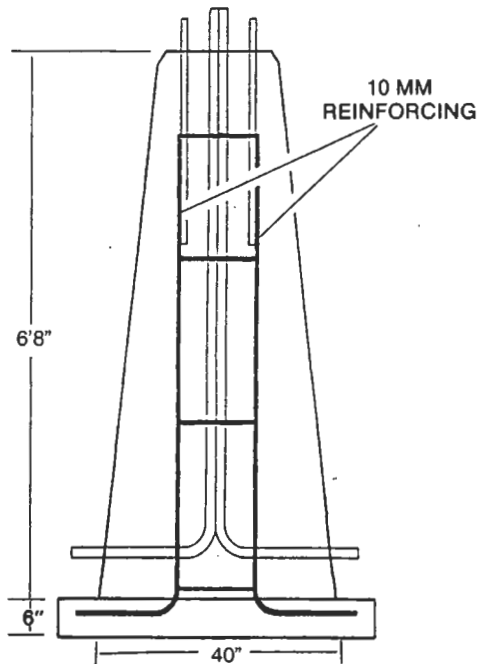

- SPECIFICATIONS:**
- 5000 PSI at 28 days
  - 10 mm reinforcing as shown
  - Anchor bolts and conduits as per customer specifications
  - Air entraining: 5-7%

- NOTES:**
- Quick installation results in minimum disruption of traffic
  - Depth of concrete footings below grade minimizes frost movement
  - Can be produced with galvanized corner protector